

PX710M+

# DMX Controller Master

User manual



# Table of Contents

1 Description.....	4
2 Safety conditions.....	5
3 Connectors and control elements.....	6
4 Screen and buttons.....	7
4.1 Navigating the menu.....	7
4.2 Main window.....	8
4.3 Controller status.....	8
4.3.1 Digital inputs.....	9
4.3.2 Analog inputs.....	9
4.3.3 DMX output.....	10
4.3.4 DMX input.....	10
4.3.5 Running scenes.....	11
4.3.6 Running programs.....	11
4.4 Clock.....	12
4.5 Events.....	12
4.6 Channel test.....	13
4.7 Screen settings.....	14
4.7.1 PIN protection.....	15
4.8 Information about the driver.....	16
4.9 Network settings.....	16
4.10 Restart.....	17
5 Network settings of the controller.....	18
5.1 Change of the computer network configuration.....	20
5.2 Connecting controller directly to the PC.....	23
5.3 Connecting the controller using a router.....	23
5.3.1 Automatic addressing.....	24
5.3.2 Static addressing.....	25
6 Logging into the controller.....	25
6.1 Logging in to the controller in the local network.....	26
6.2 Remote logging (external network).....	26
6.2.1 Logging in via the PxDesigner application.....	28
6.2.2 Login from the PxMini and PxMobile applications.....	33

7 Software installation.....	36
7.1 Windows®.....	36
7.2 Android™.....	38
8 Controller configuration.....	39
8.1 Zones.....	39
8.2 Scenes.....	40
8.3 Programs.....	41
8.4 Shows.....	42
8.5 Masks.....	44
8.6 Sequences.....	47
8.7 Statuses.....	47
8.8 Group of associated items.....	48
8.9 Events.....	49
8.10 Action limitations.....	50
8.11 Delay.....	51
9 Controller operation.....	52
9.1 Calculation of outputs values.....	52
9.2 Modbus.....	53
9.3 Live mode.....	64
9.4 Indication lights.....	65
9.5 RESET button operation and restoring default settings.....	66
9.6 Core mode, FTP support.....	67
10 Connection scheme.....	68
11 Dimensions.....	73
12 Technical data.....	73

*Manufacturer reserves the right to make modifications in order to improve device operation.*

PXM Marek Żupnik sp.k.  
Podłęże 654  
32-003 Podłęże  
BDO register number 000005972

tel. +48 12 385 83 06  
mail: info@pxm.pl  
www.pxm.pl

Rev.1-0  
19.01.2022

# 1 Description

---

The PX710M+ DMX Controller Master is an advanced architectural lighting controller that allows for controlling even the most complex lighting systems. With programmable functions, the device enables the control of lighting, multimedia, and other devices that are operated based on the DMX protocol.

The controller has 2 DMX output line (1024 channels), 1 DMX input line, and it allows for triggering multiple configuration items at the same time. Additionally, the number of output lines can be extended using PX710S+. The PX710S+ allows to extend the installation by 1024 DMX channels (max. 7 x PX710S+ devices).

Events can be triggered by an astronomical clock, a real time clock, programmed timers, analogue or digital inputs, mobile device applications or via the Modbus protocol.

An advanced PC application PxDesigner (Windows®) allows for programming the device. The application has a built-in library of devices that can be distributed on a graphic project, which facilitates the creation of complex light shows, including ones that are synchronized with sound.

The PX710M+ has a screen and buttons, so user can read the basic operating parameters. Thanks to the BUS1 and BUS2 buses, the device can be extended with additional PX723 Keyboard 8, PX734 Light & Movement Sensor and PX778 Extension module 8ch modules. Two independent buses can be connected in series with max. 32 modules each (max. 64 modules in total).

The controller comes with an application for mobile devices (Android™, iOS) which enables simple control.

The controller can be used to create up to 16 users with different access rights. There is an option to remotely log on to the controller from the external network.

## 2 Safety conditions

---

PX710M+ DMX Controller Master is a device powered with safe voltage 12 – 24V DC, however, during its installation and use the following rules must be strictly observed:

1. The device can be connected to 12 – 24V DC (stabilized voltage) with current-carrying capacity compatible with technical data.
2. All the conductors should be protected against mechanical and thermal damage.
3. In case of damage to a conductor, it should be replaced with a conductor of the same technical parameters.
4. Connection of DMX signal can be made with a shielded conductor only.
5. All repairs, connecting and disconnecting of cables can only be made with cut off power supply.
6. The device should be strictly protected against contact with water and other liquids.
7. All sudden shocks, particularly dropping should be avoided.

8. The device cannot be turned on in places with humidity exceeding 90%.
9. The device cannot be used in places with temperature lower than +2°C or higher then +40°C.
10. Clean with damp cloth only.

### 3 Connectors and control elements

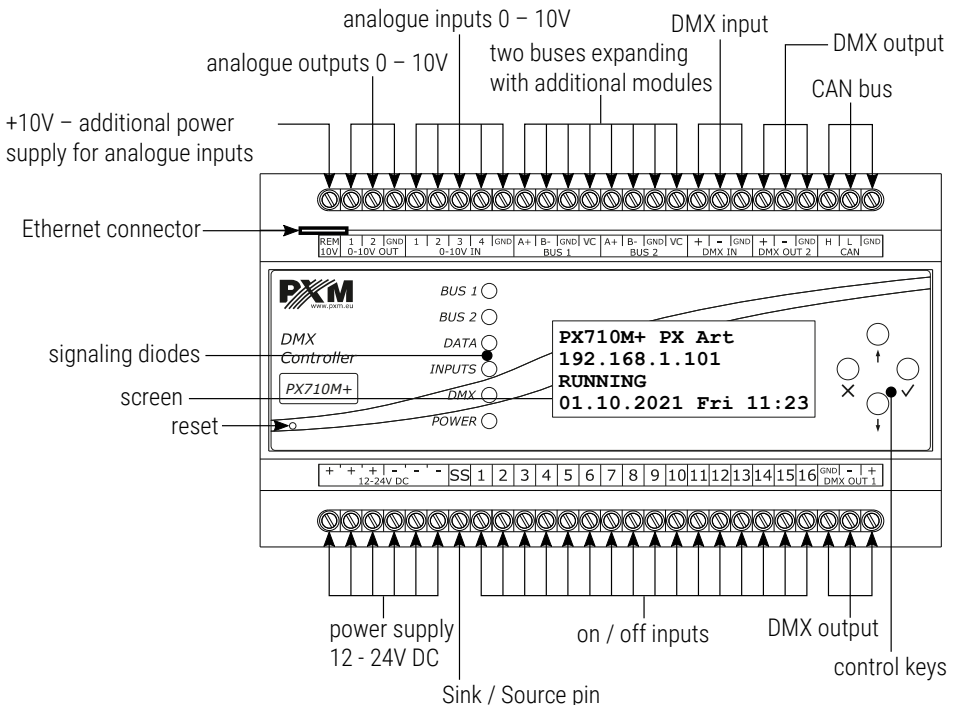

# 4 Screen and buttons

---

## 4.1 Navigating the menu

- ✕ (escape) - allows to exit the parameter being programmed without saving any changes or to move to a higher menu level
- ↓ (next) - scrolls the menu down or reduces the values to be set
- ↑ (prev) - scrolls the menu up or increases the values to be set
- ✓ (enter) - allows to enter the programming mode and confirm the values set

The ► symbol indicates the currently selected parameter, which will be entered after clicking the *enter* button. The symbols ▼ and ▲ inform the user that it is possible to scroll the screen and display other options (with the *prev* or *next* buttons).

The currently edited parameter is marked with angle brackets *<parameter>*.

## 4.2 Main window

The start screen, which is visible after starting the device, contains: model and serial number of the device, its current IP address, status as well as date and time on the device.

PX710M+ 21320345
192.168.1.101
RUNNING
01.10.2021 Fri 11:23

Possible statuses are:

- **RUNNING** – normal device operation,
- **STOP** – the operation of the device is suspended (e.g. due to the lack of configuration).

## 4.3 Controller status

In the **CONTROLLER STATUS** tab you can preview:

- digital inputs,
- analog inputs,
- DMX outputs,
- DMX input,
- running scenes,
- running programs.



### 4.3.1 Digital inputs

In the **DIGITAL INPUTS** menu, in the **CONTROLLER STATUS** tab, you can view the status of digital inputs: 16 internal (in) and 1024 external (ex).

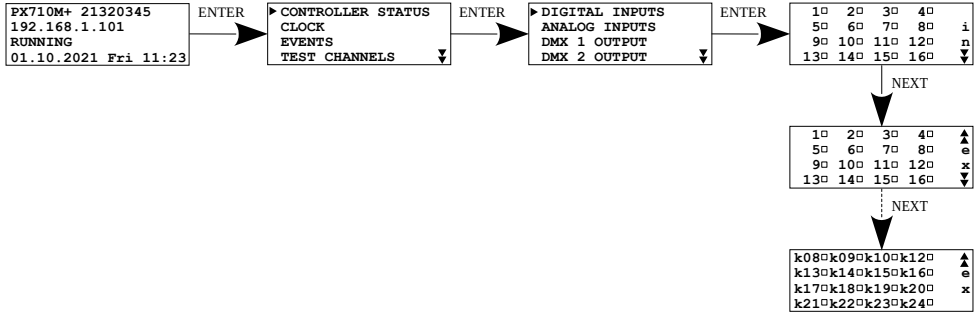

- input is open
- input shorted

### 4.3.2 Analog inputs

In the **ANALOG INPUTS** menu, in the **CONTROLLER STATUS** tab, you can view the status of analog inputs (4). You can read the voltage at the analog input along with the DMX signal control level.

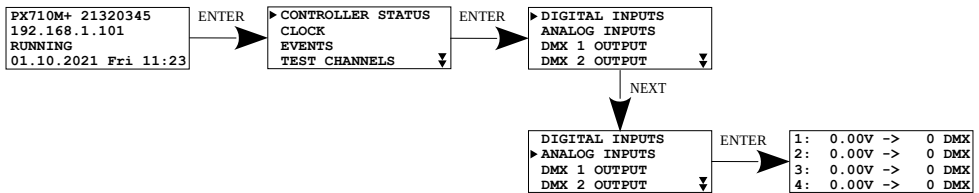

### 4.3.3 DMX output

In the **DMX OUTPUT** menu, in the **CONTROLLER STATUS** tab, you can read the DMX control level values on each channel. The information is displayed 12 channels per screen.

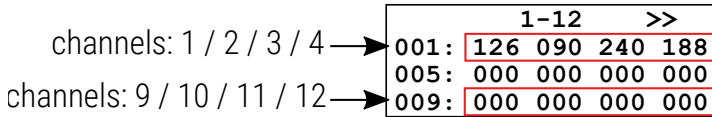
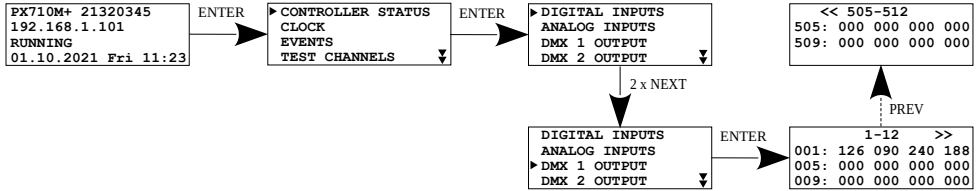

### 4.3.4 DMX input

In the **DMX INPUT** menu, in the **CONTROLLER STATUS** tab, you can read the DMX control level values on each input channel. The information is displayed 12 channels per screen.

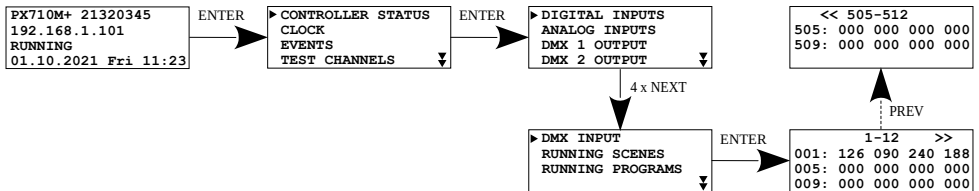

### 4.3.5 Running scenes

In the **RUNNING SCENES** menu on the **CONTROLLER STATUS** tab you can see which scenes are currently running.

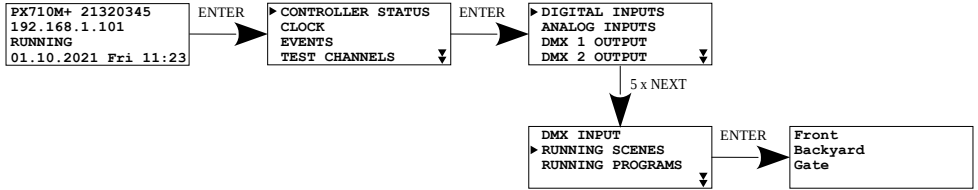

**No Running Scenes** is displayed on the screen when no scene is running. The list is refreshed when you enter the scenes preview.

### 4.3.6 Running programs

In the **RUNNING PROGRAMS** menu in the **CONTROLLER STATUS** tab you can view which programs are currently running.

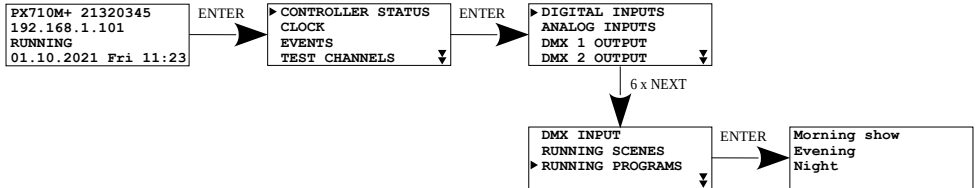

**No Running Programs** is displayed on the screen when no program is running.

The list is refreshed when you enter the programs preview.

## 4.4 Clock

In the **CLOCK** menu, you can read the current date, day of the week and time, in addition, the controller displays the **SUNRISE** and **SUNSET** times of the sun.

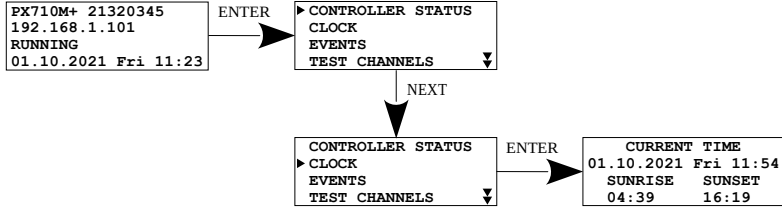

## 4.5 Events

The **EVENTS** menu displays the available events, in this menu you can start events by selecting them with the *prev* and *next* buttons and then pressing the *enter* button.

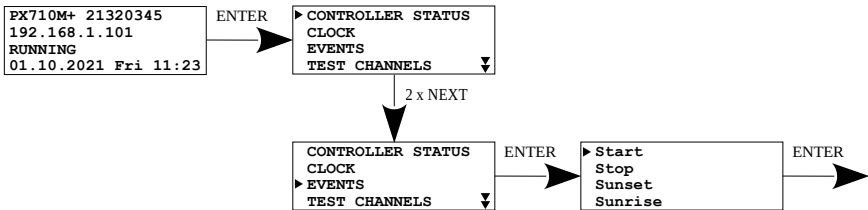

**NOTE!** The triggering of an event is signaled by the fading of the screen backlight.

## 4.6 Channel test

The **TEST CHANNELS** allows to drive **ALL** channels to the maximum value – 255. It is also possible to control individual channels. This option can be useful for testing the connection on the DMX line between the controller and the signal receiver.

Press the *enter* button to switch the DMX test signal on and off, while the *prev* and *next* buttons change the DMX channels or select the **ALL** option.

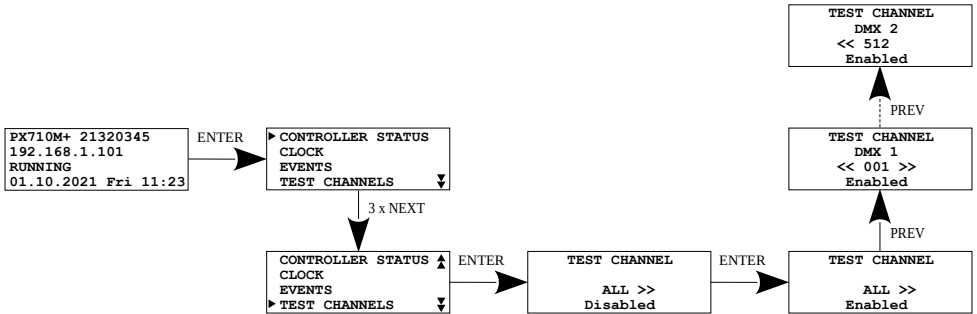

**NOTE!** When you exit this menu, signal testing automatically changes to the *Disabled* trim.

## 4.7 Screen settings

**LCD SETTINGS** allows to change the brightness of the display, the values are expressed as a percentage (0%, 25%, 50%, 75%, 100%). In this menu, the user can enable the **DARK MODE** option, i.e. turning off the screen backlight after ~15 seconds of inactivity.

The device will continue to work without interfering with other parameters. To restore the backlight, press any key.

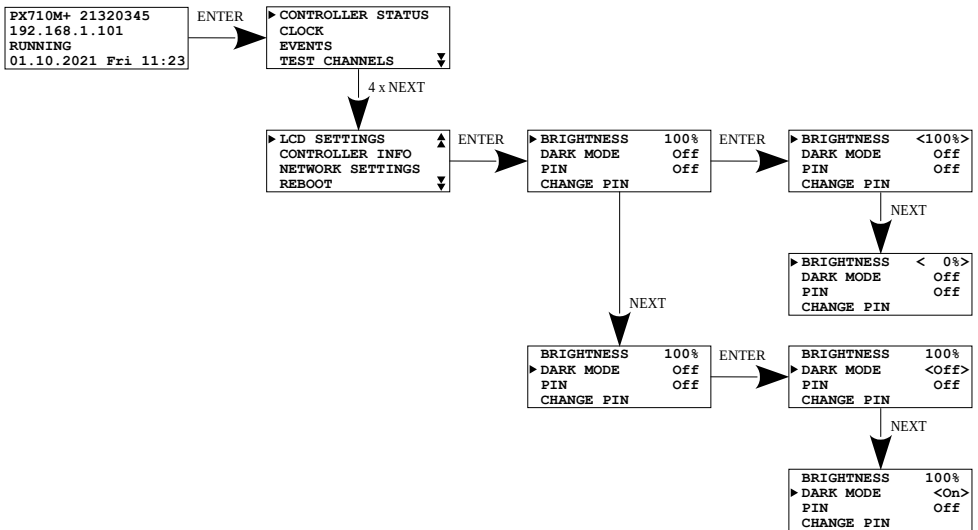

**NOTE!** Active **DARK MODE** turns off the backlight only on the main window.







## 4.10 Restart

The **REBOOT** tab in the menu includes the following options:

- **REBOOT** – restarting the device,
- **FACTORY DEFAULTS** – factory reset:
  - IP: 192.168.0.50
  - Mask: 255.255.255.0
  - Device name: Px710M+ [serial number]
  - ADMIN account password: [serial number]
  - Remove configuration – configuration can still be downloaded in PxDesigner
- **RESET NETWORK** – reset network settings:
  - IP: 192.168.0.50
  - Mask: 255.255.255.0
  - Gateway: 192.168.0.100
  - DHCP: On
- **LOGOUT ALL USERS** – logout of all users currently connected to the controller

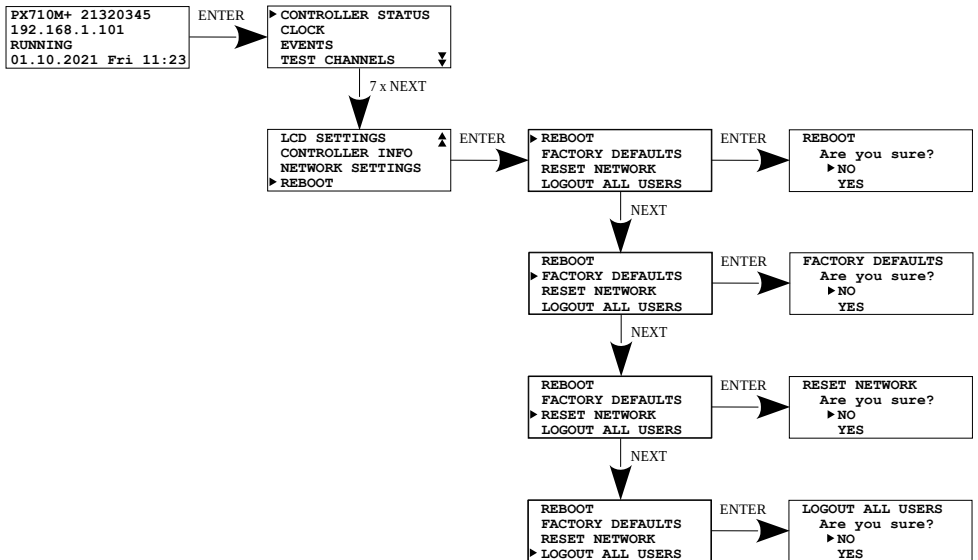

## 5 Network settings of the controller

The controller stores the static network configuration. It is always used when static addressing mode was selected or in automatic addressing mode, when it was not possible to get the configuration settings from the DHCP server.

The controller can run in one of two modes:

- automatic addressing from DHCP server
- static addressing

In automatic mode (DHCP), after connecting to the network the controller attempts to get the network configuration from a DHCP server (e.g router). Thanks to this, manual configuration of networks parameters is not needed. In

the absence of a DHCP server on the network the controller will operate according to the static configuration (manual setup).

When choosing static addressing, the network parameters configure should be in such a way that the controller is able to operate on the subnet and there is no conflict of IP addresses (devices in the network must have unique IP addresses).

#### The default network settings of the controller:

- **DHCP:** On
- **IP:** 192.168.0.50
- **Mask:** 255.255.255.0
- **Gate:** 192.168.0.1

If the controller operate in automatic mode in the network and receive IP address from the DHCP server, the detaching of the network cable will result in the loss of IP address and another attempt to get new IP address from the DHCP server. If that fails, the controller switches to operate with a static configuration.

It is recommended to use automatic addressing and connect the controller to the network with a running DHCP server.

Should the controller be connected directly to the computer (no DHCP server), the network parameters must be manually set of both the computer and the controller to operate in one network.

## 5.1 Change of the computer network configuration

The procedure for changing the computer network configuration varies depending on the operating system. Windows® 10 system is an example here.

Change of the computer network configuration in the Windows® 10 operating system is done in the following:

1. Click **[Start]** 
2. Select **[Settings]** tab

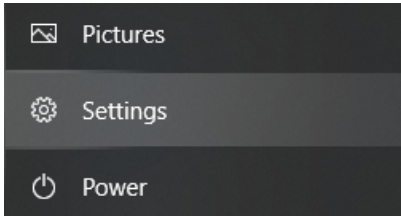

3. Go to **[Network & Internet]** tab

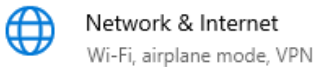

4. Select **[Advanced network settings]**

Advanced network settings

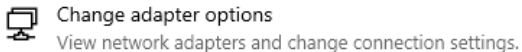

5. Right-click on the appropriate connection, for example it could be **[Ethernet]** and select **[Properties]**

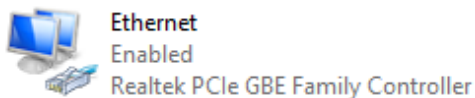

6. In the new window that appears, select **[Internet Protocol Version 4 (TCP/IPv4)]** and then press properties

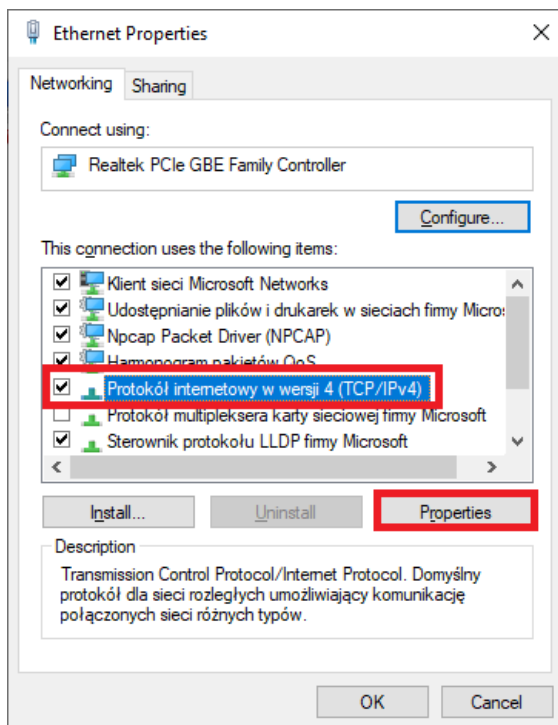

7. In the next window, select [Use the following IP address:]

To connect directly (computer – driver) with a controller that has a default configuration, use the sample settings:

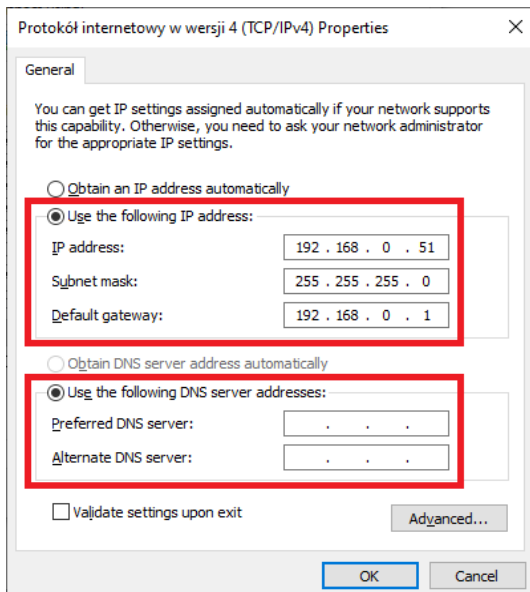

IP address: 192.168.0.51  
Subnet mask: 255.255.255.0  
Default gateway: 192.168.0.1

## 5.2 Connecting controller directly to the PC

When connecting the controller directly to a computer it is recommended to use a braided cable. Newer network cards will work both on a braided cable or a non-braided cable, but older ones may require a braided cable.

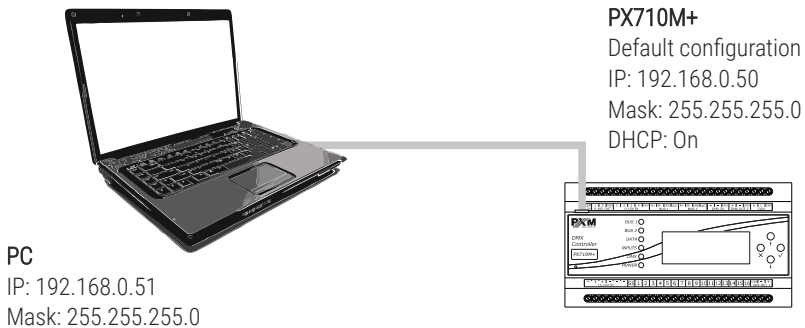

## 5.3 Connecting the controller using a router

When connecting the controller to the router, there are two options for network settings. The first of these is the use router with a DHCP server running, the network configuration on all devices in the network is set automatically. The second option is to connect the controller and devices cooperating with it to a switch or router that does not support DHCP server, in this case all devices in the network must have manually configured network settings in such a way that each device operates in the same network and has a unique IP address.

### 5.3.1 Automatic addressing

Below is a diagram of the operation of devices with the DHCP server running:

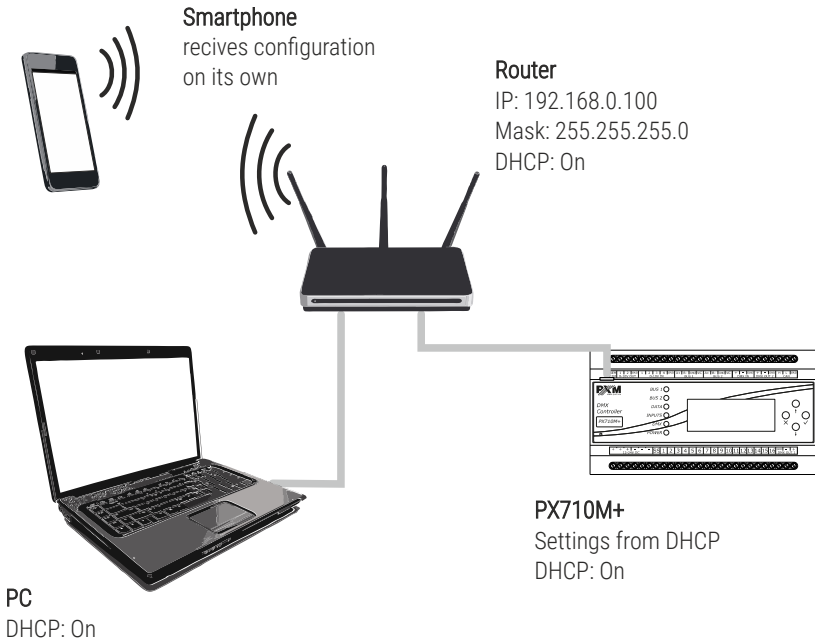



## 5.3.2 Static addressing

Below is an example diagram of network settings of the controller and devices cooperating with it, in the case when the DHCP server in the network is not running:

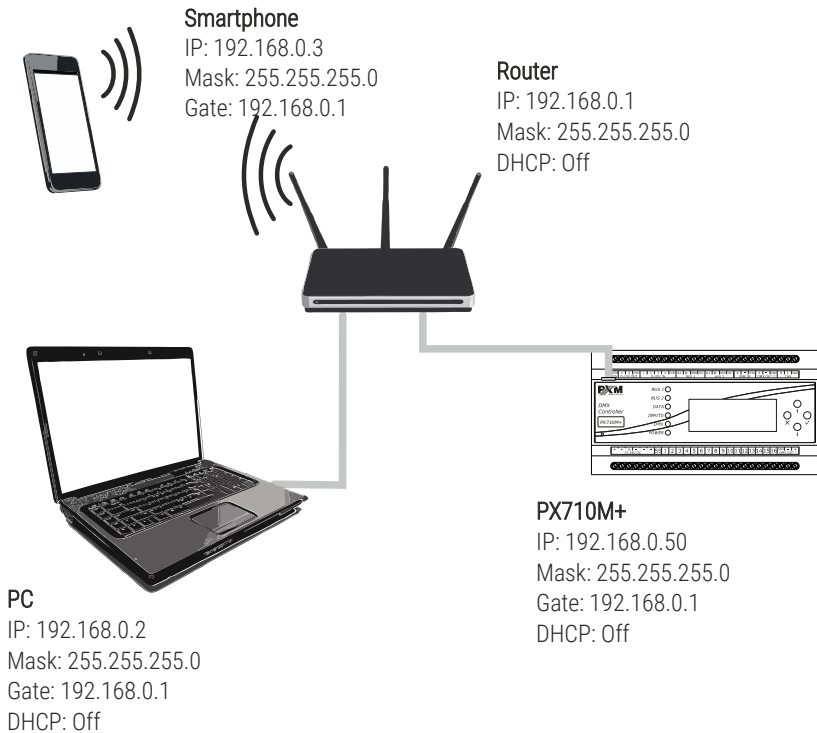

## 6 Logging into the controller

Logging into the controller is possible from the local network and from external network (Internet). In both cases, the device can be logged in from PC using the PxDesigner program to configure the device and PxMini from a mobile device via the PxMobile application (PxMini and PxMobile are used to control the controller), which already has to configured configuration. There

is always an ADMIN user in the driver, who has the maximum level of permissions. The default password ADMIN user is the serial number of the device. It is recommended to change the default password and creating user accounts with certain permissions.

## 6.1 Logging in to the controller in the local network

If the controller is connected to local network, the smartphone and the PC, and the network address settings are configured correctly, the PxMobile, PxDesigner and PxMini applications will automatically search for the driver. When connecting any application with the driver, will be required to enter the username and password.

## 6.2 Remote logging (external network)

The controller allows you to log in to the device from an external network via the internet, for this purpose it should be:

- have an external IP address on the router assigned by the internet provider and be able to establish connection from outside (incoming packets are not blocked by the provider's and router's firewall)
- redirect appropriate ports / port to the IP address of the controller working in the local network (so-called forwarding port):
  - 50000 and 50001 for the PxDesigner application
  - 50002 for the PxMini and the PxMobile applications
- unblock selected port in the router's firewall

- the address of the driver / drivers in the local network can not change (the driver must have a static IP address set or the DHCP server must assign the same addresses to the same devices each time)

**NOTE!** In most routers available on the market, you can set a static IP address by the DHCP server based on the MAC address of the device. For example, for a device with the MAC address 70:B3:D5:EF:B1:60 the IP address 192.168.1.15 will always be assigned by the DHCP server (example below).

**Static assignment**

IP Address 192.168.1.

MAC address  :  :  :  :  :

NO.	IP Address	MAC address	Delete
1	192.168.1.15	70:B3:D5:EF:B1:60	<input type="button" value="Delete"/>

Most routers available on the market usually have several parameters in port forwarding options:

- forwarding number
- port or port range for redirection
- the IP address of the device to be redirected to
- protocol type (TCP / UDP or both)
- attach / delete diversion

## 6.2.1 Logging in via the PxDesigner application

a) one controller works in the local network with the following settings:

- external IP address: 66.77.88.99 (example address)
- IP address: 192.168.1.10
- mask: 255.255.255.0
- target device port: 50000 and 50001
- protocol: TCP or TCP/UDP (in this case option "Both")

Below is the screen of the example setting in the router:

Port range forwarding sets up public services on your network, such as web servers, ftp servers, e-mail servers, and other specialized Internet applications. When you have set up one service, then the communication requests from the Internet to your router's WAN port will be converted to the specified LAN IP address.

NO.	Start port	End port	LAN IP	Protocol	Enable	Delete
1.	50000	50001	192.168.1.10	Both ▼	<input checked="" type="checkbox"/>	<input type="checkbox"/>
2.			192.168.1.	TCP ▼	<input type="checkbox"/>	<input type="checkbox"/>
3.			192.168.1.	TCP ▼	<input type="checkbox"/>	<input type="checkbox"/>
4.			192.168.1.	TCP ▼	<input type="checkbox"/>	<input type="checkbox"/>
5.			192.168.1.	TCP ▼	<input type="checkbox"/>	<input type="checkbox"/>
6.			192.168.1.	TCP ▼	<input type="checkbox"/>	<input type="checkbox"/>
7.			192.168.1.	TCP ▼	<input type="checkbox"/>	<input type="checkbox"/>
8.			192.168.1.	TCP ▼	<input type="checkbox"/>	<input type="checkbox"/>
9.			192.168.1.	TCP ▼	<input type="checkbox"/>	<input type="checkbox"/>
10.			192.168.1.	TCP ▼	<input type="checkbox"/>	<input type="checkbox"/>

Well-known service ports:

If there is no option to set the port range in the router, create two separate rules for each port separately (separately for 50000 and 50001).

If everything is correctly configured to connect to the controller from the (external) internet network, in the application click *Connect*, then select the option *Remote login* and then in the *IP* field enter the IP address of the router (assigned by the internet provider, in this case 66.77.88.99), enter the port numbers 50000 and 50001 in the fields *Port 1* and *Port 2* and then the *Login* with the user's *Password*.

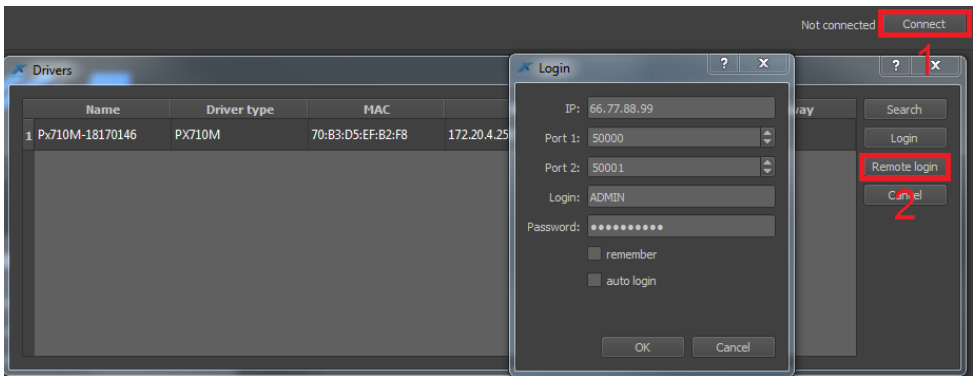

The connection diagram is on the next page.

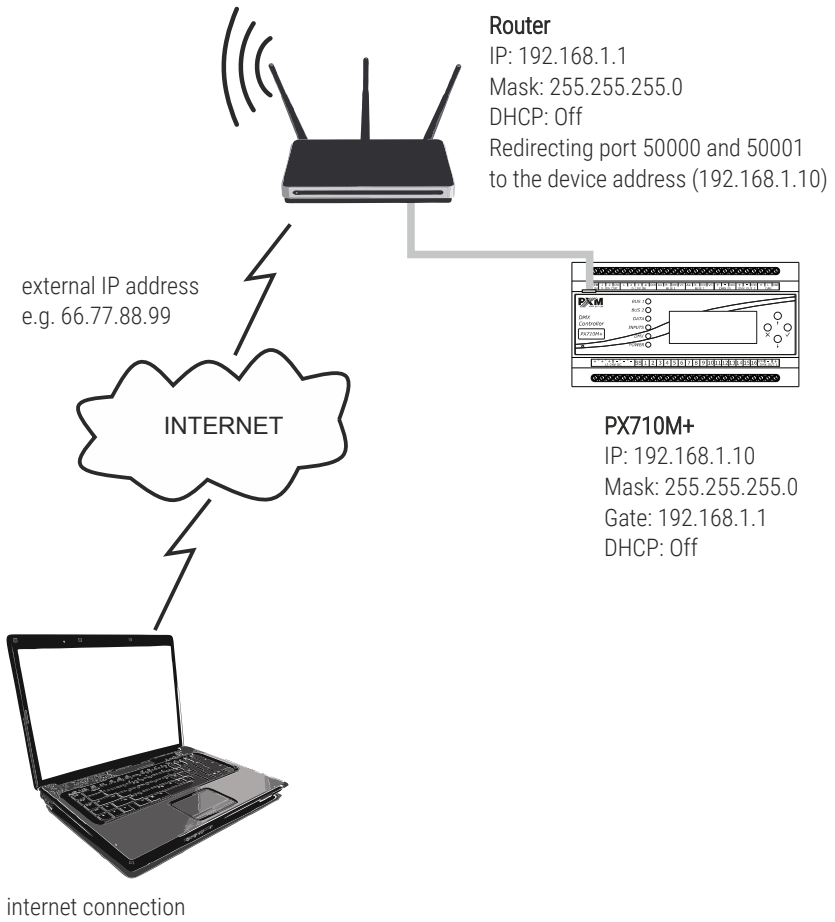

b) more then one controller works in the local network with the following settings:

- external IP address: 66.77.88.99 (example address)
- IP address of the first controller: 192.168.1.10
- IP address of the second controller: 192.168.1.11
- mask: 255.255.255.0
- target device port: 50000 and 50001 for the first controller, 60000 and 60001 for the second controller (for ports 60000 and 60001, the target port in the internal network must be 50000 and 50001 – screen)
- protocol: TCP or TCP/UDP (in this case option “Both”)

Below is the screen of the example setting in the router:

A virtual server defines the mapping from the WAN service port to the LAN server. All requests from the Internet to the designated service port will be redirected to the device specified by the server IP Address.

<input type="checkbox"/>	Service Port	IP Address	Internal Port	Protocol	Status
<input type="checkbox"/>	50000-50001	192.168.1.10	50000-50001	TCP or UDP	Enabled
<input type="checkbox"/>	60000	192.168.1.11	50000	TCP or UDP	Enabled
<input type="checkbox"/>	60001	192.168.1.11	50001	TCP or UDP	Enabled

Add New

Enable Selected

Disable Selected

Delete Selected

Refresh

The connection is exactly the same as in example 1, except that the ports 50000 and 50001 are for the first device, and the 60000 and 60001 are for the second device.

Connection example:

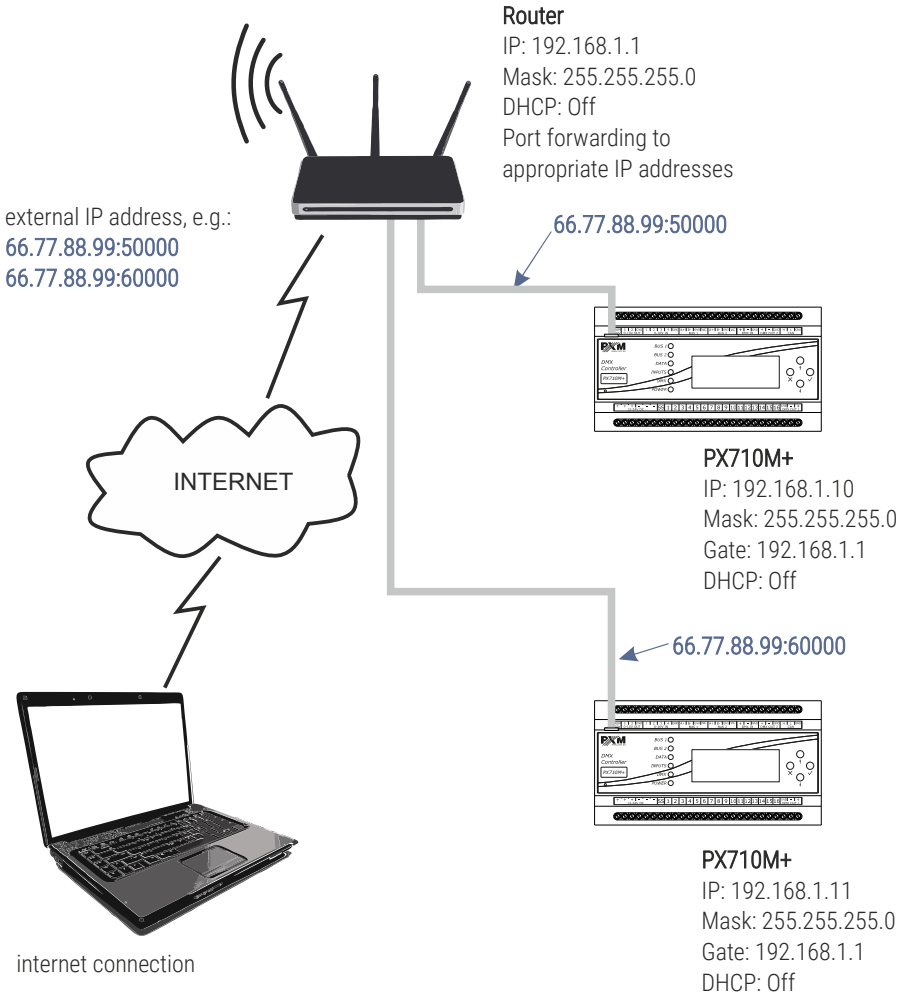



## 6.2.2 Login from the PxMini and PxMobile applications

The controller works in the local network with the following settings:

- external IP address: 66.77.88.99 (example address)
- IP address: 192.168.1.10
- mask: 255.255.255.0
- target device port: 50002
- protocol: UDP or TCP/UDP (in this case option "Both")

Below is the screen of the example setting in the router:

Port range forwarding sets up public services on your network, such as web servers, ftp servers, e-mail servers, and other specialized Internet applications. When you have set up one service, then the communication requests from the Internet to your router's WAN port will be converted to the specified LAN IP address.

NO.	Start port-End port	LAN IP	Protocol	Enable	Delete
1.	50002-50002	192.168.1.10	Both ▼	<input checked="" type="checkbox"/>	<input type="checkbox"/>
2.	<input type="text"/> - <input type="text"/>	192.168.1. <input type="text"/>	TCP ▼	<input type="checkbox"/>	<input type="checkbox"/>
3.	<input type="text"/> - <input type="text"/>	192.168.1. <input type="text"/>	TCP ▼	<input type="checkbox"/>	<input type="checkbox"/>
4.	<input type="text"/> - <input type="text"/>	192.168.1. <input type="text"/>	TCP ▼	<input type="checkbox"/>	<input type="checkbox"/>
5.	<input type="text"/> - <input type="text"/>	192.168.1. <input type="text"/>	TCP ▼	<input type="checkbox"/>	<input type="checkbox"/>
6.	<input type="text"/> - <input type="text"/>	192.168.1. <input type="text"/>	TCP ▼	<input type="checkbox"/>	<input type="checkbox"/>
7.	<input type="text"/> - <input type="text"/>	192.168.1. <input type="text"/>	TCP ▼	<input type="checkbox"/>	<input type="checkbox"/>
8.	<input type="text"/> - <input type="text"/>	192.168.1. <input type="text"/>	TCP ▼	<input type="checkbox"/>	<input type="checkbox"/>
9.	<input type="text"/> - <input type="text"/>	192.168.1. <input type="text"/>	TCP ▼	<input type="checkbox"/>	<input type="checkbox"/>
10.	<input type="text"/> - <input type="text"/>	192.168.1. <input type="text"/>	TCP ▼	<input type="checkbox"/>	<input type="checkbox"/>

Well-known service ports:  DNS(53) ▼   1 ▼

If there is no option to set one port forwarding in the router, create a range (from 50002 to 50002). If everything is correctly configured to connect to the controller from the (external) internet network, select the *Remote login* in the application (PxMini or PxMobile), and then enter the *User* and *Password* of the user and *Host* (assigned by the internet provider, in this case 66.77.88.99), in the *Port* field enter the port number (50002).

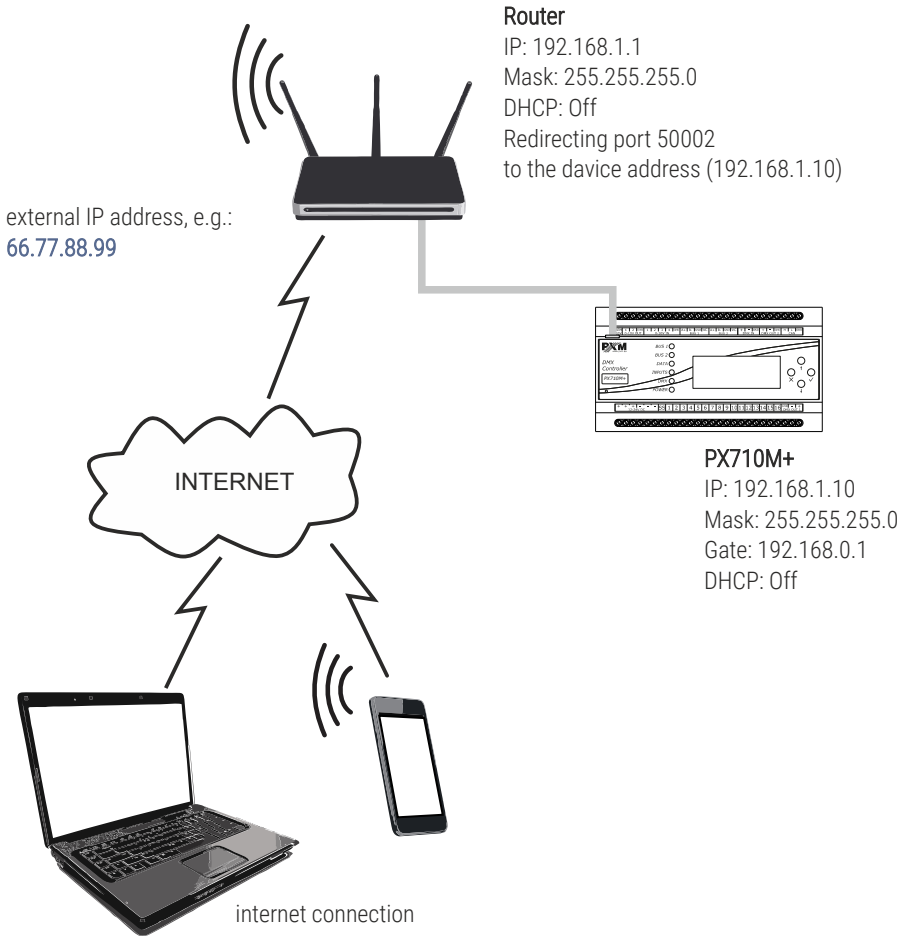

**NOTE!** If there are two controllers in network, the first one should be forwarded to the port 50002 and the second to e.g 60002 (the destination port is always port 50002).

# 7 Software installation

---

The manufacturer's website ([pxm.pl](http://pxm.pl)) includes:

- data sheet
- controller and PC software manual
- installers of programs cooperating with the controller (PxMini Windows, PxMini Linux, PxDesigner)
- file with device firmware update (the latest version at the time of recording the disc)

**NOTE!** The firmware update is recommended to be downloaded from the product page, as there is always the latest version of the device firmware update.

## 7.1 Windows®

The PxDesigner software can be installed on VISTA™, Windows® 7, Windows® 8 or Windows® 10. The procedure for installing the software varies depending on the operating system on the computer. Windows® 7 system is an example here.

## Installation is as follows:

1. Open an installation file, click **[Next]** to go to the software installation. The installation file is available for download from the manufacturer's page ([pxm.pl](#)).
2. Select the folder in which the software is to be installed. Confirm your selection by clicking the **[Next]** button.
3. Select components that you want to install and then click **[Next]**.
4. Read the license agreement carefully, if you agree to the terms of this agreement, click **[Next]** to continue installation.
5. Select the start menu in which you want to create a shortcut to the program. You can also rename the directory, then click **[Next]**.
6. The installer will ask again whether you want to install the software, click **[Install]** if you agree.
7. When the window indicating that the installation procedure was successful pops up, click **[Finish]** to exit the installation wizard. If you want to run the program, in the selection window select **[Run PxDesigner now]**.
8. Windows® display a security alert of the system and to be able to use the PxDesigner software, you need to allow access.

**NOTE!** If you previously installed an older version of PxDesigner, you should uninstall it before installing a newer version.

## 7.2 Android™

The PxMobile application can be installed on Android™ 4.0 or later.

### To install software:

1. Upload \*.apk installation file available on manufacturer's page to the phone memory.
2. Go to phone settings and then check "Allow installation of apps from sourced other than The Play Store" in the **[Security]** tab.
3. Open the application through the system **[File Manager]**.  
The screen for the installed new software pops up. This screen displays information on the phone function that the application will use.
4. To install the application press the "Install" button.

After a successful installation process, the application will be available in the application menu of the phone.

**NOTE!** The application can also be downloaded from the Google Play store by searching for the phrase "PxMini" or by scanning the QR code.



# 8 Controller configuration

---

The controller operates in accordance with the loaded configuration which is created and uploaded using the PxDesigner application. The method of creation of a configuration file is described in the manual for PxDesigner. As part of the configuration, it is possible to set the parameters for all inputs and outputs, create users and relevant configuration items.

## 8.1 Zones

A physical area in which devices are distributed. Since the device in the project are properly addressed – DMX output channels can be connected to the area. There is always one default global area in the controller that contains all the output channels. A scene, a mask or a program can be assigned to one area (by default they are assigned to the global area). The element operates only on channels that are associated with the area to which the item is assigned.

The DMX output channel can be associated with a number of areas.

When controlling with a smartphone, the control areas are visible as subsequent tabs (“*desktops*”). Users can have access to selected areas.

### Area parameters:

- name
- default value of the master parameter
- assignment of channels to area

## 8.2 Scenes

A scene is a set of values for all DMX output channels.

### Scene parameters:

- name
- rise time
- duration
- drop time
- zone to which it belongs
- group of associated items to which it belongs
- value for all DMX channels of the zone
- is it editable using a smartphone
- default master value

The rise time, duration and drop time are in the range 0 – 24h with an accuracy of 0.01s. In addition, the duration can be set to infinite. The sum of all three times cannot be 0.

Once the “*turn on scene*” action is triggered, the scene will be activated with the rise time and will last as long as the duration and will turn off automatically with the drop time. If, before the expiry of the duration the “*turn off scene*” action is triggered, the scene will also be turned off with the drop time.



## 8.3 Programs

A program is a system of subsequent scenes along with a defined input time and duration.

### Program parameters:

- name
- zone to which it belongs
- number of repetitions / loop
- number of steps
- event at the end of the program
- drop time of the last step
- drop time of the interrupted program
- default master value
- default value of speed
- list of steps
  - scene assigned to a step
  - rise time
  - duration

The pool of programs steps is separable from the scene. Each step comes with its input time, lasts as long the duration and drops with the rise time of the next step. The last step drops with its drop time, if this is the end of the program or with the rise time of the first step, if the program is looped or played back repeatedly.

All times are multiplied by the current value of the “*speed*” parameter. The value of 1.00 is a neutral value and a default value. For 2.55 all the times are extended 2.5 times and for 00.1 the times are divided by 100. For the value of 0, all the times are shorten to the minimum value (0.01s) – if the time was set to 0 – it remains 0.

The transition between the value of the following steps (at the moment when one of them is turned on and the other is turned off) is linear.

If the program is turned off, it drops when the interrupted programs fade, or if it is not defined – with the drop time of the current step.

## 8.4 Shows

The show is a record of the time path with elements (scenes, programs or DMX streams) placed on it. It can be edit at any time. The show is not a part of the controller configuration, it is saved in the project.

Generating a DMX stream is a frame-by-frame record of DMX values which the controller transfers to the output without enumeration. Stream can be captured from the DMX input and saved to the controller or generate from the show.

## Program parameters:

- name
- zone to which it belongs
- group to which it belongs
- duration
- number of repetitions / loop
- event at the end of the program
- default master value
- default value of speed

The rise and fall times are included in the duration and indicate the penetration of the start and end of the element tile. The method of penetration depends on the mode of merging. The rise and fall times determine the percentage (0 – 100%) of a given element in the process of calculating the final value at a given moment.

For example, if the cursor is within 1/10 of the rise time of a given element, then 10% of the channel values for this element and 90% of the channel values from the layers below are taken.

## The modes of merging elements in the show:

- covering
- higher wins
- alpha
- light
- water
- color
- brightness
- white balance
- add
- subtract
- multiplication
- mask

## 8.5 Masks

A mask is a set of values assigned to output channels, which modifies a value at the DMX output. Masks take the precedence over scenes and programs.

There are 3 types of masks:

- **proportional** – it changes all values in the channel proportionally to the values of the mask

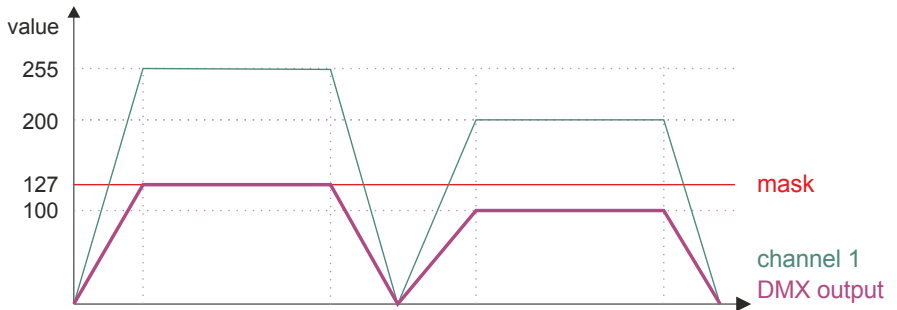

- **maximal** – it converts all the values in the channel that are greater than the value of the mask to the value of the mask

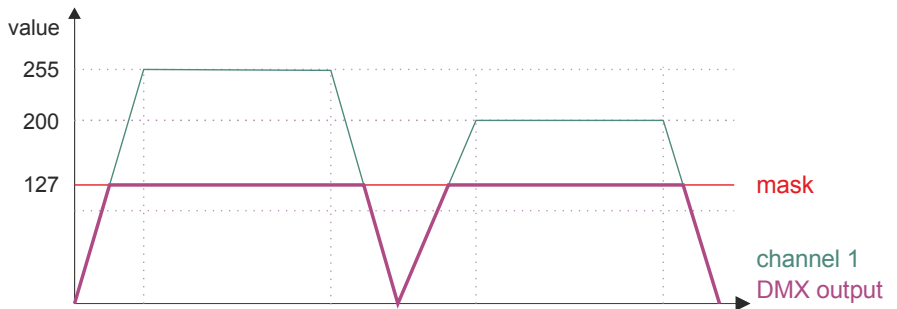

- **minimal** – it changes all the values in the channel that are smaller than the values of the mask to the values of the mask

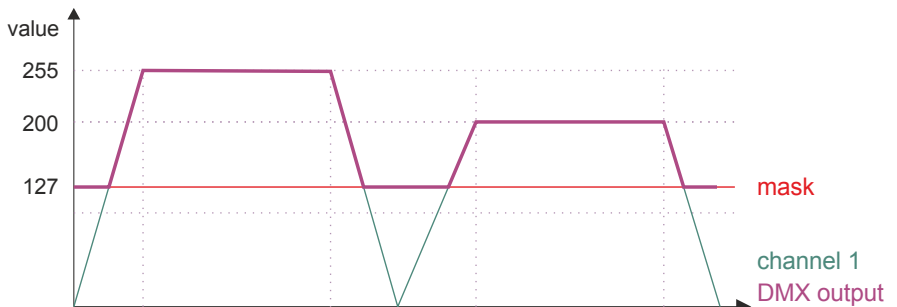

## Mask parameters:

- name
- rise time
- duration
- drop time
- zone to which it belongs
- value for all DMX channels of the zone
- type:
  - proportional
  - minimum value
  - maximum value

## If several masks are turned on at a time:

- from all the proportional masks turned on in the zone, the lowest value for each channel is taken into account
- from all the minimum masks turned on in the zone, the highest value for each channel is taken into account
- from all the maximum masks turned on in the zone, the lowest value for each channel is taken into account
- if for any channel 2 masks are turned on which exclude themselves with their effects – the channel is set to 0

## 8.6 Sequences

A sequence is a set of successive steps, each of which may trigger several actions in parallel and take a set amount of time.

### Sequence parameters:

- name
- number of steps
- list of steps
  - step duration
  - list of actions

The sequence is not assigned to the area. A launched sequence plays all the steps one by one. For each step it performs all the actions from its list, and then it waits for the duration of a given step and moves to the next step.

The list of possible actions is the same as for the event. The sequence may trigger other sequences, including itself.

## 8.7 Statuses

A status is an internal state of the device that allows for a conditional start of selected actions. The status can be switched on and off. The fact whether the selected status is turned on or off determines the execution of another action (e.g scene start).

## 8.8 Group of associated items

Scenes, programs and shows can belong to different areas in one group of associated elements. Items that are associated cannot be run at the same time, which is why turning on an item belonging to a group turns off all other elements belonging to this group. Each element can belong to one group only.

The transition between the values of the associated items (at the moment when one of them is turned on and the other is turned off) is linear from value to value.

An example of a value transition in a channel for associated items:

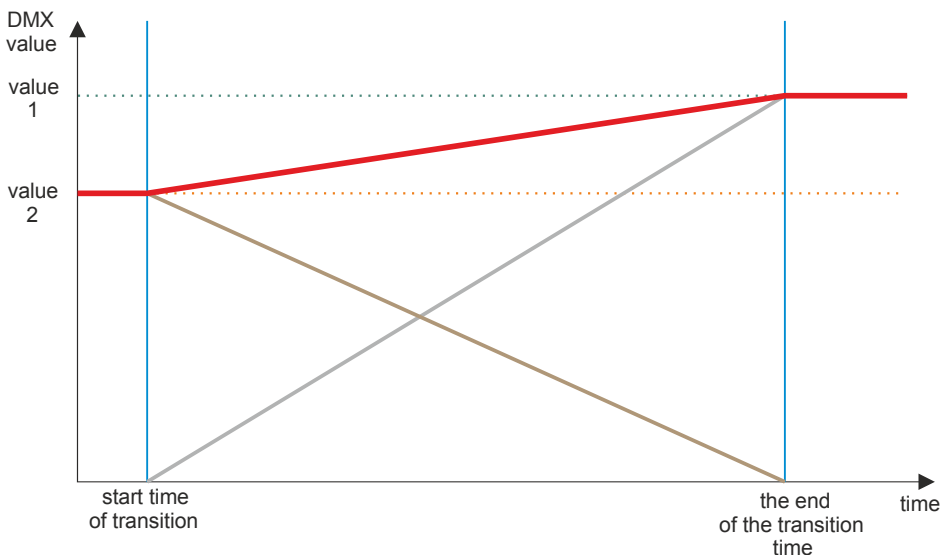



## An example of a value transition in a channel for non-associated items:

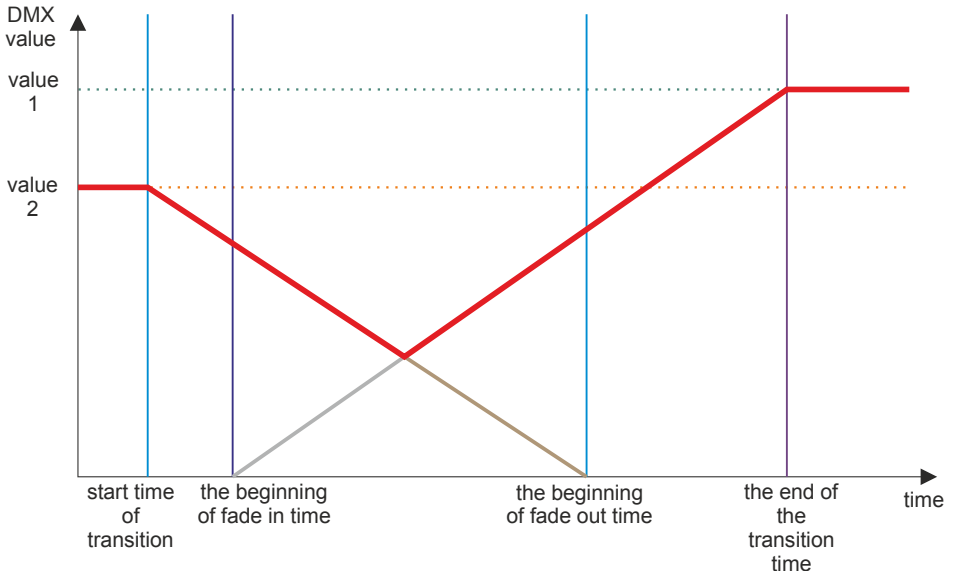

## 8.9 Events

An event is the execution of a list of actions as a reaction to a specific signal. Events can be generated in different ways:

- **internal** – can be triggered by:
  - touchpanel
  - smartphone
  - controller start
  - end of program
  - an internal event can have a value (e.g events caused by the slider on the touchpanel)

- **from ON /OFF inputs** – two events assigned to each input:
  - rising edge
  - trailing edge
- **from multi-value inputs** – (DMX input, analogue input, Modbus, PID) depending on the settings of a given input – one or two events
- **from the clock** – timers and astronomical clock:
  - sunrise and sunset – with a possibility to move forward or backward (24h)
  - timers
- **delays** – can be triggered by:
  - other event
  - end of program

## 8.10 Action limitations

Each action on the list may have its conditions that must be met to trigger the action. All conditions for a given actions must be met at a given time.

- **Daily limitation:**
  - only during the day – from sunrise to sunset
  - only at night – from sunset to sun rise
  - from sunrise to set hour
  - from sunset to set hour
  - from set hour to sunrise
  - from set hour to sunset

While calculating the sunrise / sunset time, the movement of the sunrise / sunset entered by the user is taken into account.

- **Status limitation** – for each status an action can:
  - ignore its state
  - start only if a status is set
  - start only if a status is not set

An action will be triggered if all the conditions of the statuses are met in a given moment.

## 8.11 Delay

The delay is a list of actions (such as for the event) which will be executed after the set time expires. The delay must be activated by another event.

Delay parameters:

- name
- countdown time
- list of actions

The start of the delay starts the counting of the set time. If the time runs out, the list of actions is triggered. If the delay is switched off before the set time, the countdown will be stopped and the actions will not be executed. The restart of the delay starts the counting from the beginning.

## 9 Controller operation

---

The controller works in accordance with a preloaded configuration: in response to relevant events it executes the programmed actions that can turn on or off the selected configuration items. Triggering events and starting configuration elements is done in the master controller. Expansion modules only have additional DMX outputs.

### 9.1 Calculation of outputs values

The value on DMX output depends on currently run scenes, programs, masks and shows, and the settings of the DMX output channels, and the activated signal transmission from the input.

For each output channel, the highest value of this channel from all running scenes, programs and shows is taken into account. The scenes and programs are affected by their *“master”* parameters. In addition, the calculated value is modified by the *“master”* zone parameter to which a given channel belongs.

This calculated value passes through the limitations set by the currently running masks and limitations set for various DMX output channels.

If signal transmission from one input is turned on, the depending on the settings, the value for the output channel is taken directly from the input or merged with a value calculated by the controller in accordance with the pre-set function.

The controller calculates and sends to the output as many channels as there are set in the settings of the DMX output in the configuration.

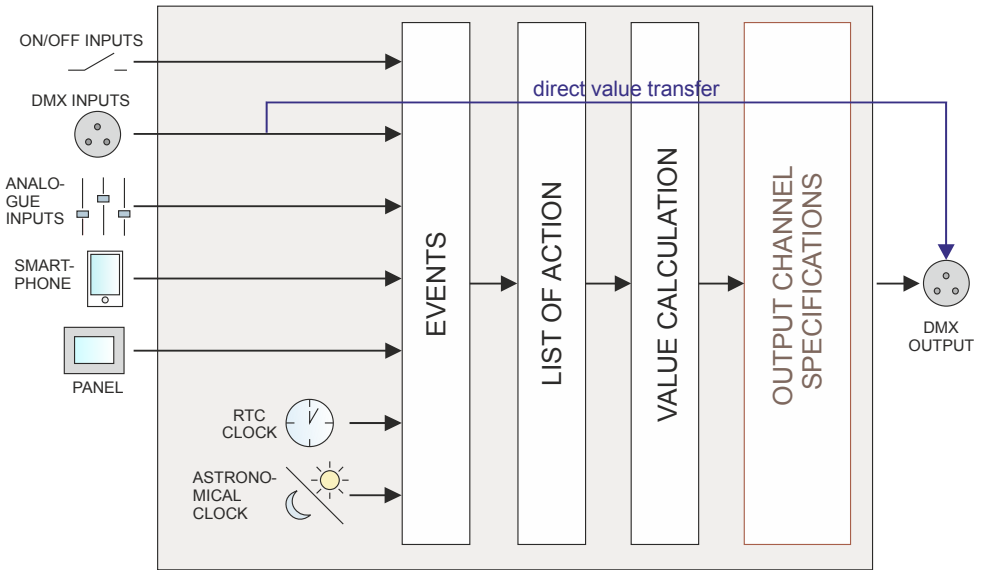

## 9.2 Modbus

The controller supports the Modbus TCP/IP protocol. A PX710M+ controller operates as a server (slave), to which an application / a device operating as a client (master) connects. The master establishes a connection through TCP port 502 (a standard Modbus port) using the current IP address of the controller. At any given time, only one master can be connected to the controller.

In Modbus TCP protocol, data are transmitted in packets referred to as ADUs (Application Data Unit). An ADU is composed of a header (MBAP Header) and a PDU (Protocol Data Unit). According to the standard, all data sent using Modbus protocol are represented as Big endian (most significant byte coming first).

Single packet:

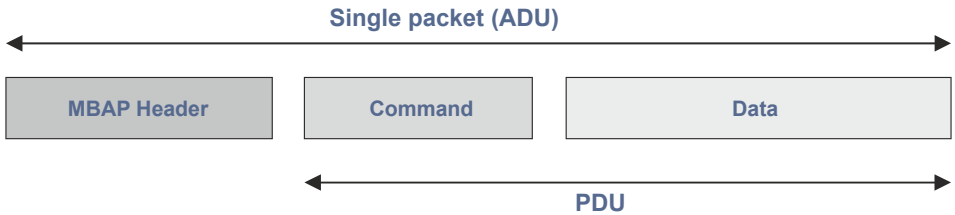

Field	Description	Size
<b>MBAP</b>		
Transaction ID	Packet number – for purpose of simplification it can be equal to 0	2B
Protocol ID	For the Modbus protocol it is <b>always equal to 0</b>	2B
Lenght	The number of subsequent data (after this field) transmitted – in bytes	2B
Unit ID	It is always equal to 0 or 255	1B
<b>PDU</b>		
Function Code	A Modbus command – supported commands are set out in table (a – commands)	1B
Address / Action	For standard Modbus commands, these are register addresses – table (d – register addresses), for special commands these are action numbers – table (c – actions)	2B
Parameters	Command-dependent – available in table (c – actions)	Size in the table (c – actions)

## Example 1:

A query about 10 first DMX channels in hexadecimal notation reads as follows:

00 00 00 00 00 06 00 03 20 00 00 0A

PDU explained:

03 – Modbus function code: 03, meaning “*Read Holding Registers*”

20 00 – address of the register being read – 0x2000 = 8192 – corresponds to DMX output channels

00 0A – number of registers requested – 0x00A = 10 – DMX channels

Expected response:

00 00 00 00 00 17 00 03 14 00 xx 00 xx 00 xx 00 xx 00 xx 00 xx 00 xx 00 xx 00 xx

Except for the “*Length*” field, the header is always the same as in the query.

The function code is copied from the query.

14 – 0x14 = 20 – the number of bytes read

00 xx – the values of subsequent DMX channels, where xx is within the range 0x0000 to 0x00FF, meaning from 0 to 255

## Example 2:

Writing a value of 255 to the first Modbus register. The controller will treat the register as a Modbus input channel. You can set the response of the controller to a change of value in the channel in the tab *"Input → Modbus"* (in the PxDesigner application).

00 00 00 00 00 06 00 06 00 00 00 FF

PDU explained:

06 – Modbus function code: 06, meaning *"Write Single Register"*

00 00 – register address 0x0000 = 0 (registers are addressed from 0)

00 FF – channel value (range 0 – 255)

The controller will respond with the same message.



### Example 3:

Hexadecimal notation for a TCP frame that triggers scene No 1:

00 00 00 00 00 0B 00 45 01 00 00 00 01 00 00 00 00

or

00 00 00 00 00 07 00 45 01 00 00 00 01

PDU explained:

45 – Modbus function code: 0x45 = 69, triggering an action

01 – “scene start” action

00 00 00 01 – first argument – scene number

00 00 00 00 – second argument – not used in this case

It can be omitted in respect of actions that do not require a second argument (but remember to change the value of “Lenght” field from 0x0B to 0x07).

Scene and program numbers are assigned when the configuration is uploaded into the controller. In order to identify the index of a scene or a program uploaded into the controller, start the relevant element and read the numbers as shown in the controller preview.

When sending or receiving multiple parameters using a single command (e.g “Write Multiple Registers” – function code 0x10) you can transmit up 125 values in one message.

Below there are presented Modbus commands supported by the controller:

**a) Commands**

Modbus command		Controller reaction
<b>standard</b>		
1	Read Coils	<i>not supported</i>
2	Read Discrete Inputs	returns the state of digital inputs in bits
3	Read Holding Registers	returns the status of the controller
4	Read Input Registers	returns the status of the controller
5	Write Single Coil	<i>not supported</i>
6	Write Single Register	sets the value of a single input channel of the Modbus
15	Write Multiple Coils	<i>not supported</i>
16	Write Multiple Register	sets the value of many input channels of the Modbus
<b>own</b>		
65	Internal event	triggers an internal event with no value, the argument is the number of a virtual event
66	Internal event	triggers several internal events without values, the arguments are the numbers of virtual events
67	Internal event	triggers an internal event with a value, the first argument is the number of virtual events, the second is the value of the event
68	Internal event	triggers several internal events with values, the arguments are the numbers of virtual events
69	Action	triggers a specific action
70	Action	triggers many actions

In the case of the “*Write Single Register*” command, the Modbus input is treated as a multi-value input with 512 channels. The parameters of each channel are set in the same manner as in the case of a DMX input.

**b) Returned states**

Element	Size	Description
Scene status data	2B	state
	2B	master
	4B	time left [ms]
	8B	reserved
Program status data	2B	state
	2B	master
	2B	speed
	2B	repeat count
	2B	current step
	3B	step time left [ms]
	8B	reserved
Mask status data	2B	state
	2B	master
	4B	time left [ms]
	8B	reserved
Sequence status data	2B	state
	2B	current step
	4B	time left [ms]
	8B	reserved

Element	Size	Description
Delay status data	2B	state
	4B	time left [ms]
	8B	reserved
Film status data (playing)	2B	state
	2B	master
	2B	speed
	2B	repeat count
	4B	current step
	8B	reserved

### c) Actions

Number	Action	Parameters	
0	no action	scene number	-
1	on	scene number	-
2	off	scene number	-
3	solo	scene number	-
4	toggle	scene number	-
5	pause	scene number	-
6	resume	scene number	-
7	set master	scene number	master value
8	increase master	scene number	-
9	decrease master	scene number	-
10	on	mask number	-
11	off	mask number	-
12	solo	mask number	-
13	toggle	mask number	-
14	pause	mask number	-
15	resume	mask number	-
16	set master	mask number	master value
17	increase master	mask number	-
18	decrease master	mask number	-
19	on	program number	-
20	off	program number	-
21	toggle	program number	-
22	pause	program number	-
23	solo	program number	-

Number	Action	Parameters		
24	Program	restart	program number	-
25		set master	program number	master value
26		increase master	program number	-
27		decrease master	program number	-
28		set speed	program number	master value
29		accelerate	program number	-
30		slow down	program number	-
31		next step	program number	-
32		previous step	program number	-
33		Sequence	on	sequence number
34	off		sequence number	-
35	off all		sequence number	-
36	Delay	on	delay number	-
37		off	delay number	-
38		restart	delay number	-
39	Status	set	status number	-
40		delete	status number	-
41		toggle	status number	-
42	Transmission	DMX input on	-	-
43		DMX input off	-	-
44	Send a signal to the panel		address panel	signal number

Number	Action	Parameters		
45	Zone	set master	zone number	master value
46		increase master	zone number	-
47		decrease master	zone number	-
48		off all	zone number	-
49	Modbus	transmission on	-	-
50		transmission off	-	-
51	Analogue inputs	transmission on	-	-
52		transmission off	-	-
53	Film	on	film number	-
54		off	film number	-
55		solo	film number	-
56		toggle	film number	-
57		stop	film number	-
58		restart	film number	-
59		set master	film number	master value
60		increase master	film number	-
61		decrease master	film number	-
62		set speed	film number	master value
63		accelerate	film number	-
64		slow down	film number	-
65		turn on recording	film number	-
66		resume recording	film number	-
67		turn off recording	film number	-

## d) Register addresses

Addressing	Size	Data	Read / write
0x0000 – 0x01FF	1kB	Modbus “input” channels	R / W
0x0400 – 0x05FF	1kB	DMX input channels	R
0x0800 – 0x09FF	1kB	analogue input channels	R
0x0C00 – 0x0FFF	2kB	digital inputs	R
0x1400 – 0x15FF	1kB	statuses	R
0x2000 – 0x23FF	2kB	DMX output channels	R
0x4000 – 0x49FF	5kB	films	R
0x6000 – 0x75FF	11264B	programs	R
0x9000 – 0xAFFF	16kB	scenes	R
0xD000 – 0xD7FF	4kB	masks	R
0xE000 – 0xE3FF	2kB	sequences	R
0xE800 – 0xF5FF	7168B	delays	R

## 9.3 Live mode







When connected to a computer or a smartphone, the controller can be switched to live mode. In this mode, the controller operates normally in the background, however at the output it sends the currently edited scene or a program step (only for those channels that are covered by the zone to which a scene or program belongs – on other channels it sends the calculated values).

Where there are several controllers connected to each other in a system, then at a given moment live mode can be activated only on one of the controllers.



## 9.4 Indication lights

The controller is quipped with 6 indicator lights:

Indicator	Action	Function
green  BUS 1	flashing	the driver transmits or receives packets on the bus
green  BUS 2		
green  DATA	flashing	receiving data from a PC application or smartphone
green  INPUTS	single blink	information about shorting of one of the digital inputs
blue  DMX	flashing	the DMX signal is sent
yellow  POWER	permanent light	the device is running and working in normal mode
	fast flashing	the device is running and has stopped in core mode
	slow flashing	the device is in normal mode, but it has no configuration (at the same time the DMX indicator is blinking), the DMX signal is not transmitted

## 9.5 RESET button operation and restoring default settings

Action	Reaction
Holding down the button when the power supply is turned on	Switching the device to the core mode
Holding down the button for 2 seconds when the device is in the core mode	Switching the device to the normal operating mode
Holding down the button for 5 seconds when the device is in the core mode	Uploading a configuration from the built-in memory to the device
Holding down the button for 5 seconds in the normal operating mode	Network settings reset – signaled by lighting up the DMX diode and the POWER diode
Holding down the button for 10 seconds in the normal operating mode	Reset of all settings (including the name of the controller), ADMIN account password and erasing the configuration uploaded into the device – these are signaled by all the six indicator diodes illuminating

**NOTE!** Default parameters are:

**IP:** 192.168.0.50

**Mask:** 255.255.255.0

**Gate:** 192.168.0.100

**Device name:** Px710M+ [serial number]

**ADMIN account password:** [serial number]

## 9.6 Core mode, FTP support

After switching to the core mode (stop in the bootloader), it is possible to connect the controller using the FTP protocol. In this mode, you should always connect to the default static address on the controller from the ADMIN account level, by providing the default password (device serial number) – even if it has been changed.

Direct connection (cable) – assumptions:

- a computer with a stable IP in the same sub-network as the controller
- the controller in the core mode, i.e the PWR diode flashes

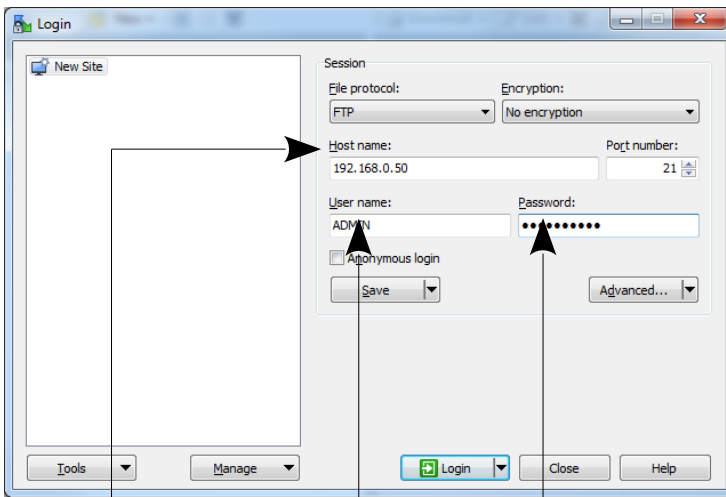

user name: ADMIN

static address of the controller

ADMIN password  
(serial number)

**NOTE!** Recommended FTP client is the free WinSCP program.

The connection to the controller via FTP can be useful when it is not possible to upload the firmware update via the application. Then, replace the "UPGRADE.upg" file in the controller and exit the core mode (by force). The controller will be automatically updated. Using the FTP it is possible to delete the uploaded configuration.

## 10 Connection scheme

a) power connection, DMX input and output, PC and the PX703 touchpanel

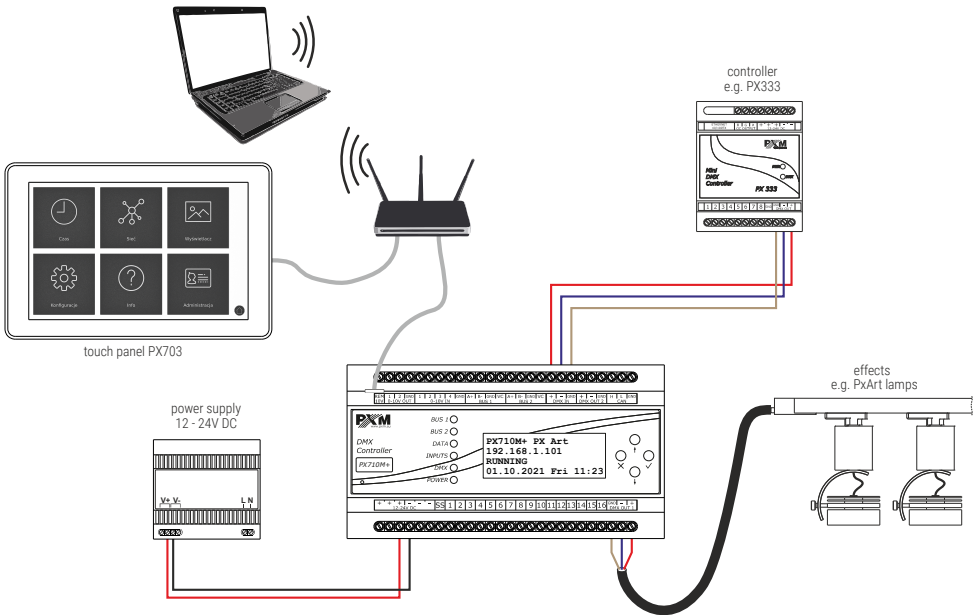

## b) connection of analogue inputs

### SOURCE SIGNAL 0 - 10V

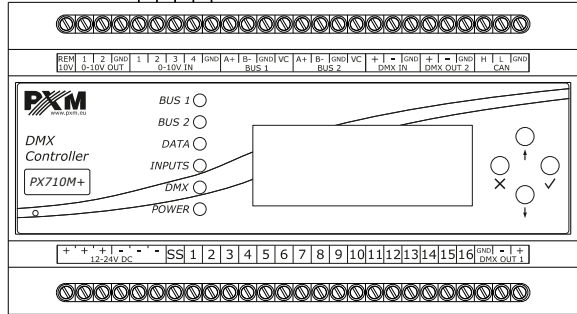
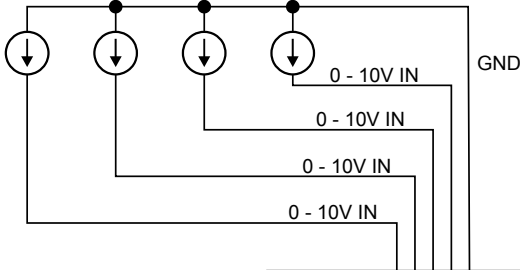

### POTENTIOMETERS

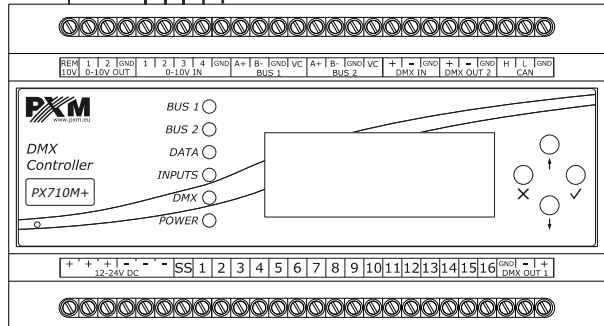
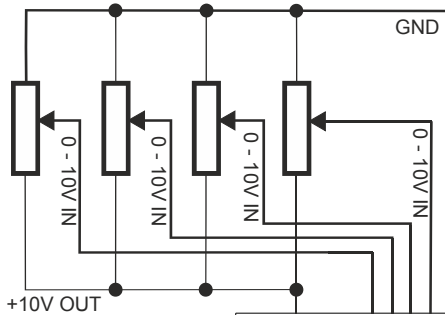

c) connection of external PX734 / PX723 devices (motion sensor / keyboard)

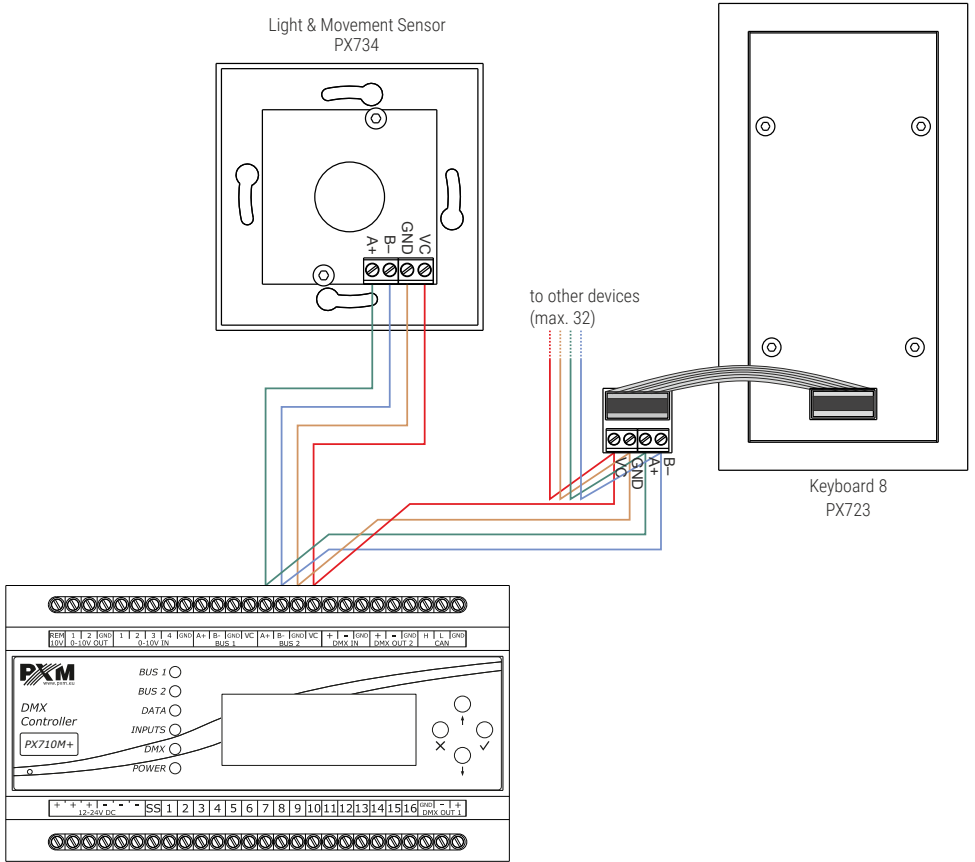

d) connection of digital inputs (sink in) – positive logic input – “joint plus”

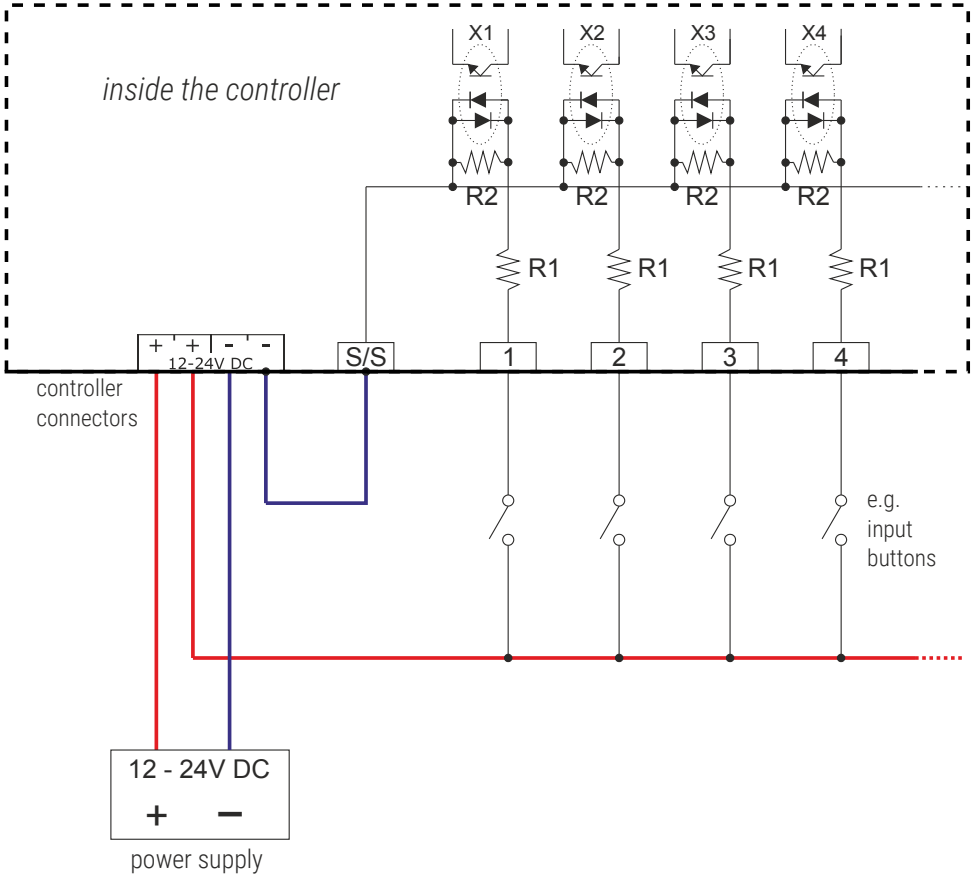

e) connection of digital inputs (source in) – negative logic input - "joint mass"

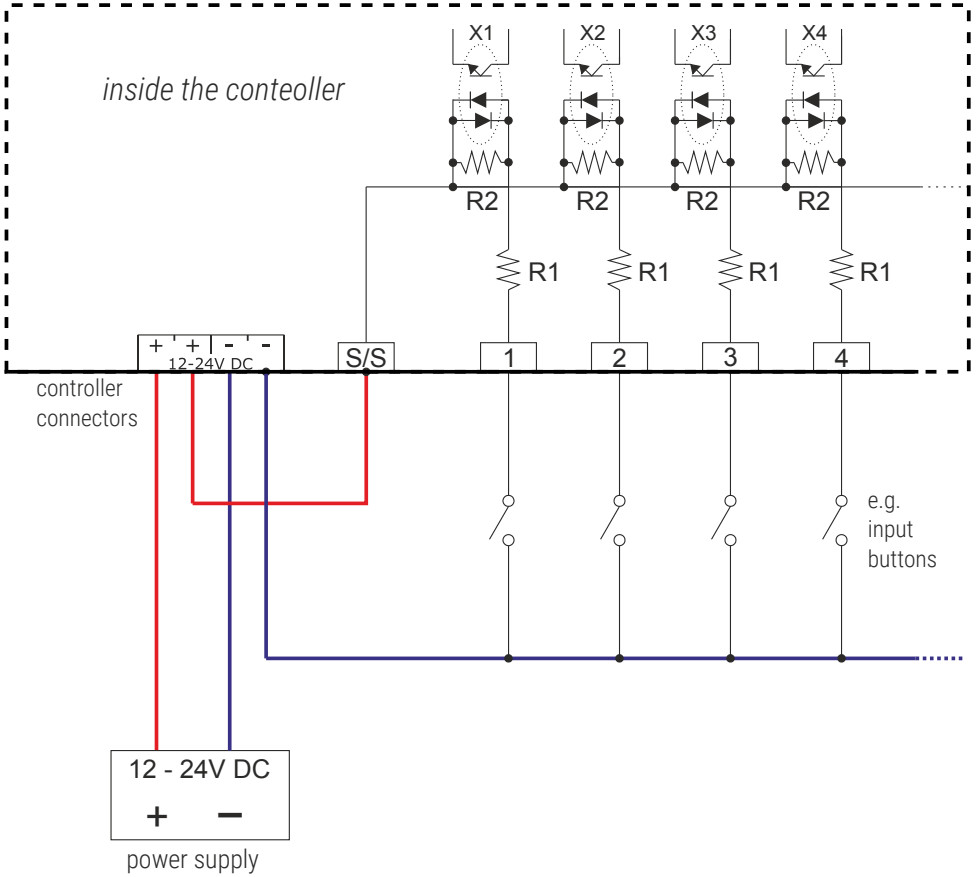



# 11 Dimensions

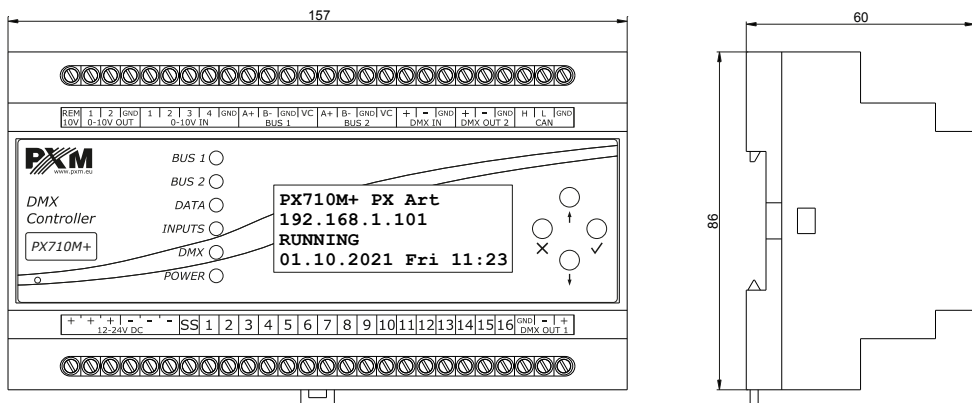

# 12 Technical data

type	PX710M+
power supply	12 – 24V DC
max. power consumption	7W (without external devices connected to the <i>BUS1</i> and <i>BUS2</i> )
DMX input	1 (512 channels)
DMX output	2 (2 x 512 channels)*
control inputs (on / off)	16
analog inputs	4
REM 10V output load	max. 20mA
analog outputs	2
load on analog outputs	max. 10mA / channel
maximum number of external devices	64 (max. 32 for one BUS line)
external touchpanels	max. 16

Ethernet port	1
Real Time Clock (RTC)	yes
Modbus	TCP
scenes and programs steps	251000
number of scenes running simultaneously	max. 200
programs	512 (max. 40 simultaneously)
sequences	128
statuses	256
timers	1024
zones	32
users (including ADMIN)	16
weight	0.3kg
dimensions	width: 157mm (9 DIN rail modules)
	height: 86mm
	depth: 60mm

\* - possibility of expansion using PX710S+ (max. 7 devices, 1024 DMX channels each)

## DECLARATION OF CONFORMITY

PXM Marek Żupnik spółka komandytowa  
Podłęże 654, 32-003 Podłęże

we declare that our product:

*Product name:* DMX Controller Master

*Product code:* PX710M+

meets the requirements of the following standards, as well as harmonised standards:

PN-EN IEC 63000:2019-01	EN IEC 63000:2018
PN-EN 61000-4-2:2011	EN 61000-4-2:2009
PN-EN IEC 61000-6-1:2019-03	EN IEC 61000-6-1:2019
PN-EN IEC 61000-6-3:2021-08	EN IEC 61000-6-3:2021

and meets the essential requirements of the following directives:

2011/65/UE **DIRECTIVE OF THE EUROPEAN PARLIAMENT AND OF THE COUNCIL** of 8 June 2011 on the restriction of the use of certain hazardous substances in electrical and electronic equipment  
Text with EEA relevance.

2014/30/UE **DIRECTIVE OF THE EUROPEAN PARLIAMENT AND OF THE COUNCIL** of 26 February 2014 on the harmonisation of the laws of the Member States relating to electromagnetic compatibility (recast)  
Text with EEA relevance.

  
**Marek Żupnik spółka komandytowa**  
32-003 Podłęże, Podłęże 654  
NIP 677-002-54-53



mgr inż. Marek Żupnik.